

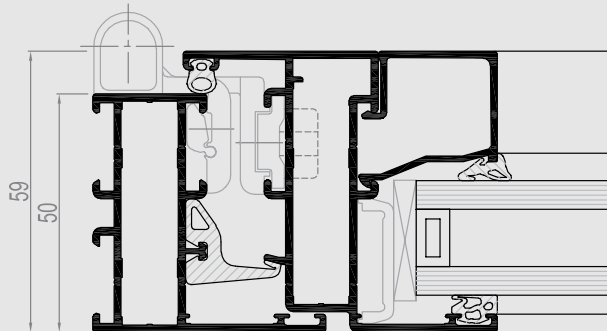

CS 59Pa

Ideal in warm climates

R
REYNAERS
aluminium

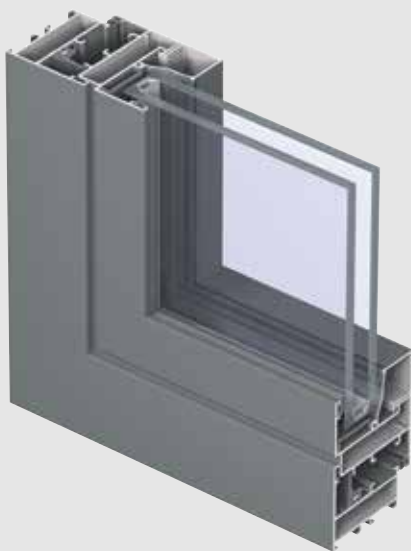

CS 59Pa offers an extensive range of non-insulated profiles for the construction of elegant and moderately priced aluminium frames in functional style. Therefore CS 59Pa is the ideal system for outdoor applications in warm climates but it can also be used for the partitioning of indoor office spaces.





The system is available in inward and outward opening windows and inward and outward opening flush doors.



TECHNICAL CHARACTERISTICS

| Style variants | | FUNCTIONAL | RENAISSANCE |
|---|-------|--|-------------|
| Min. visible width inward opening window | Frame | 49 mm | 55 mm |
| | Vent | 31 mm | 31 mm |
| Min. visible width outward opening window | Frame | 19.5 mm | - |
| | Vent | 89 mm | - |
| Min. visible width inward opening window door | Frame | 60 mm | - |
| | Vent | 64 mm | - |
| Min. visible width inward opening flush door | Frame | 61.5 mm | - |
| | Vent | 72.5 mm | - |
| Min. visible width outward opening flush door | Frame | 36.5 mm | - |
| | Vent | 97.5 mm | - |
| Min. visible width T-profile | | 74 mm | 74 mm |
| Overall system depth window | Frame | 50 mm | 59 mm |
| | Vent | 59 mm | 68 mm |
| Rebate height | | 25 mm | 25 mm |
| Glass thickness | | up to 35 mm | up to 35 mm |
| Glazing method | | dry glazing with EPDM or neutral silicones | |

PERFORMANCES

| COMFORT | | | | | | | | | | | | |
|---|---|--|---------------|----------------|----------------|----------------|----------------|----------------|----------------|----------------|---------------|--------------------|
|  | Acoustic performance ⁽¹⁾ EN ISO 140-3; EN ISO 717-1 | Rw (C; Ctr) = 36 (-1; -3) dB / 44 (-2; -4) dB, depending on glazing type | | | | | | | | | | |
|  | Air tightness, max. test pressure ⁽²⁾ EN 1026; EN 12207 | 1 (150 Pa) | | 2 (300 Pa) | | 3 (600 Pa) | | 4 (600 Pa) | | | | |
|  | Water tightness ⁽³⁾ EN 1027; EN 12208 | 1A (0 Pa) | 2A (50 Pa) | 3A (100 Pa) | 4A (150 Pa) | 5A (200 Pa) | 6A (250 Pa) | 7A (300 Pa) | 8A (450 Pa) | 9A (600 Pa) | E (750 Pa) | |
|  | Wind load resistance, max. test pressure ⁽⁴⁾ EN 12211; EN 12210 | 1 (400 Pa) | | 2 (800 Pa) | | 3 (1200 Pa) | | 4 (1600 Pa) | | 5 (2000 Pa) | | Exxx (>2000 Pa) |
| | Wind load resistance to frame deflection ⁽⁴⁾ EN 12211; EN 12210 | A (≤1/150) | | | | B (≤1/200) | | | | C (≤1/300) | | |
| SAFETY | | | | | | | | | | | | |
|  | Burglar resistance ⁽⁵⁾ ENV 1627 - ENV 1630 | WK 1 | | | | WK 2 | | | | WK 3 | | |

This table shows possible classes and values of performances. The values indicated in red are the ones relevant to this system.

- (1) The sound reduction index (Rw) measures the capacity of the sound reduction performance of the frame.
- (2) The air tightness test measures the volume of air that would pass through a closed window at a certain air pressure.
- (3) The water tightness testing involves applying a uniform water spray at increasing air pressure until water penetrates the window.
- (4) The wind load resistance is a measure of the profile's structural strength and is tested by applying increasing levels of air pressure to simulate the wind force. There are up to five levels of wind resistance (1 to 5) and three deflection classes (A,B,C). The higher the number, the better the performance.
- (5) The burglar resistance is tested by static and dynamic loads, as well as by simulated attempts to break in using specified tools.